



OPTO ENGINEERING

ILLUMINATOR DATA

LTZPFL080-00-6-R-24V

Lighting Dimension

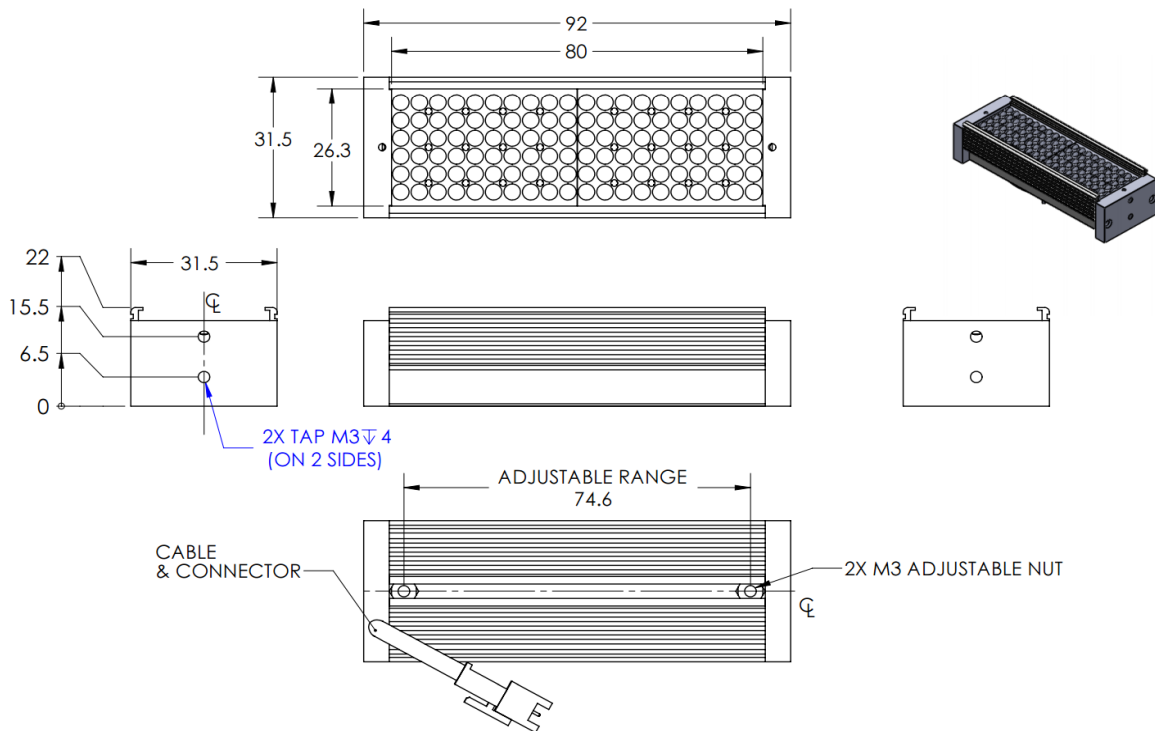

Mechanical Information

| | |
|---------------------------|-----------|
| Casing Material | Aluminium |
| Storage Temperature Range | 0 - 45°C |
| Storage Humidity Range | 20 - 85% |
| Weight | 100g |
| Length / Outer Diameter | 92mm |
| Width / Inner Diameter | 31.5mm |
| Thickness / Height | 22mm |



OPTO ENGINEERING

ILLUMINATOR DATA

LTZPFL080-00-6-R-24V

| Lighting Information | | | |
|---|----------------------------|---------|---------|
| Part Number | LTZPFL080-00-6-R-24V | | |
| LED Color | RED | | |
| Wavelength | 630nm | | |
| Working Distance | 100 mm | 130 mm | 150 mm |
| Intensity ($\pm 15\%$) | 6860 lx | 4730 lx | 3830 lx |
| Illumination (number of row) | 6 | | |
| Illumination Active Area | Active Length / Outer Dia. | 80 mm | |
| | Active Width / Inner Dia. | 26.3 mm | |
| Emission angle | 0 | | |
| Eye Safety Class (IEC62471) | EXEMPT | | |
| Chromaticity Table For White colour only | Nil | | |

| Electrical Information | |
|---|---------------|
| Rated Constant Voltage | 24V $\pm 2\%$ |
| Rated Constant Current | 156mA |
| Power Consumption | 3.74W |
| Casing temperature, After 60 minutes operation | 51.5 °C |

| Strobe Mode Specification | | |
|-------------------------------|-------------|-------------|
| *Normal Strobe Voltage | 24 V | |
| *Normal Strobe Current | 156 mA | |
| Overdrive Voltage Range | Min: 36V | Max: 48V |
| Overdrive Current Range | Min: 0.41 A | Max: 0.72 A |
| Recommended Overdrive Voltage | 36V | |
| **Max. Trigger Pulse Duration | 10 msec | |
| **Max. Duty Cycle | 10% | |

*Normal strobe means the lighting is operated using the rated power. Overdrive means the power supplied to the lighting exceeded the rated power.

**Overdrive condition must not exceed the max. trigger pulse duration and max. duty cycle.

ILLUMINATOR DATA

LTZPFL080-00-6-R-24V

| Connection Information | | | |
|--|-------------|--------|--------------|
| Connector Type (Default) | JST SMR-03V | | |
| Cable Length | 50 cm | | |
| Pin Configuration  | Pin | Signal | Cable Colour |
| | 1 | LED + | Red |
| | 2 | N.C | - |
| | 3 | LED - | White |
|  | | | |

| Additional Information | |
|--------------------------------|--|
| Additional Cooling Method | Attached to machine part for better heat dissipation |
| Intensity Controller Selection | SD, ST, ANG, LC, SDA, SDP series |
| CE Conformity | YES |
| RoHS Compliance | YES |

| Application | |
|-------------------|--|
| Illumination Type | Direct Illumination |
| Application Use | Label Inspection, Character Inspection, Code Recognition |



OPTO ENGINEERING

ILLUMINATOR DATA

LTZPFL080-00-6-R-24V

| Lighting Pattern | | | | |
|-------------------|--|-----------|----------|-----------|
| Working Distance | For further details please contact us. | | | |
| Display and Image | | | | |
| Data Results | Horizontal | Meas.(mm) | Vertical | Meas.(mm) |
| | 90% | | 90% | |
| | 80% | | 80% | |
| | 70% | | 70% | |
| | 60% | | 60% | |
| | 50% | | 50% | |
| | 40% | | 40% | |
| | 30% | | 30% | |
| | 20% | | 20% | |
| | 10% | | 10% | |
| | | | | |